

# MC74HC595A

## 8-Bit Serial-Input/Serial or Parallel-Output Shift Register with Latched 3-State Outputs

### High-Performance Silicon-Gate CMOS

The MC74HC595A consists of an 8-bit shift register and an 8-bit D-type latch with three-state parallel outputs. The shift register accepts serial data and provides a serial output. The shift register also provides parallel data to the 8-bit latch. The shift register and latch have independent clock inputs. This device also has an asynchronous reset for the shift register.

The HC595A directly interfaces with the SPI serial data port on CMOS MPUs and MCUs.

#### Features

- Output Drive Capability: 15 LSTTL Loads
- Outputs Directly Interface to CMOS, NMOS, and TTL
- Operating Voltage Range: 2.0 to 6.0 V
- Low Input Current: 1.0  $\mu$ A
- High Noise Immunity Characteristic of CMOS Devices
- In Compliance with the Requirements Defined by JEDEC Standard No. 7A
- Chip Complexity: 328 FETs or 82 Equivalent Gates
- Improvements over HC595
  - Improved Propagation Delays
  - 50% Lower Quiescent Power
  - Improved Input Noise and Latchup Immunity
- Pb-Free Packages are Available\*



ON Semiconductor®

<http://onsemi.com>

#### MARKING DIAGRAMS

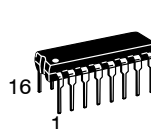

PDIIP-16  
N SUFFIX  
CASE 648

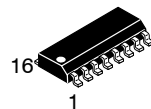
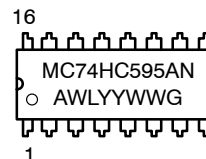

SOIC-16  
D SUFFIX  
CASE 751B

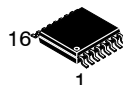
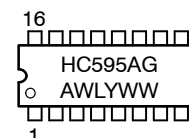

TSSOP-16  
DT SUFFIX  
CASE 948F

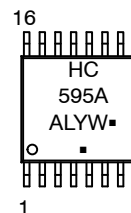

A = Assembly Location  
WL, L = Wafer Lot  
YY, Y = Year  
WW, W = Work Week  
G, ■ = Pb-Free Package

(Note: Microdot may be in either location)

#### ORDERING INFORMATION

See detailed ordering and shipping information in the package dimensions section on page 2 of this data sheet.

\*For additional information on our Pb-Free strategy and soldering details, please download the ON Semiconductor Soldering and Mounting Techniques Reference Manual, SOLDERRM/D.

# MC74HC595A

## LOGIC DIAGRAM

### PIN ASSIGNMENT

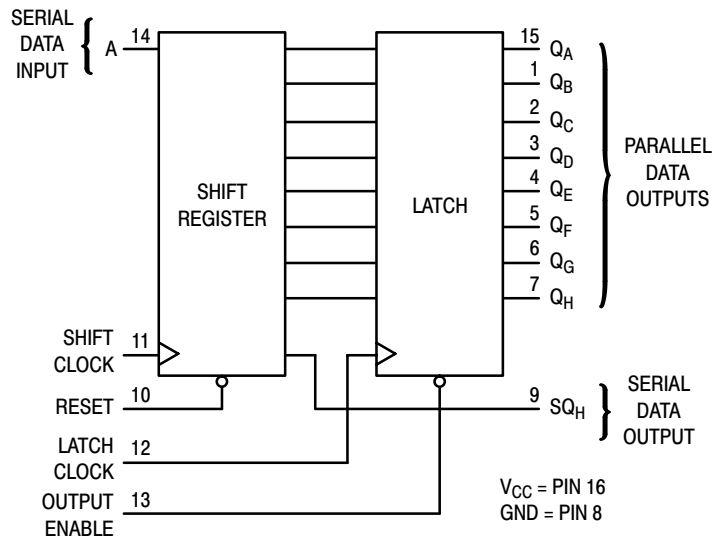
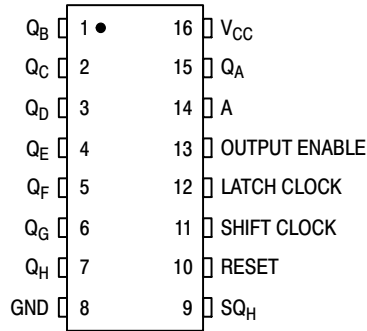

### ORDERING INFORMATION

| Device          | Package                | Shipping†        |
|-----------------|------------------------|------------------|
| MC74HC595AN     | PDIP-16                | 500 Units / Rail |
| MC74HC595ANG    | PDIP-16<br>(Pb-Free)   | 500 Units / Rail |
| MC74HC595AD     | SOIC-16                | 48 Units / Rail  |
| MC74HC595ADG    | SOIC-16<br>(Pb-Free)   | 48 Units / Rail  |
| MC74HC595ADR2   | SOIC-16                | 2500 Tape & Reel |
| MC74HC595ADR2G  | SOIC-16<br>(Pb-Free)   | 2500 Tape & Reel |
| MC74HC595ADT    | TSSOP-16*              | 96 Units / Rail  |
| MC74HC595ADTR2  | TSSOP-16*              | 2500 Tape & Reel |
| MC74HC595ADTR2G | TSSOP-16*<br>(Pb-Free) | 2500 Tape & Reel |
| MC74HC595AFEL   | SOEIAJ-16              | 2000 Tape & Reel |
| MC74HC595AFELG  | SOEIAJ-16<br>(Pb-Free) | 2000 Tape & Reel |

†For information on tape and reel specifications, including part orientation and tape sizes, please refer to our Tape and Reel Packaging Specifications Brochure, BRD8011/D.

\*This package is inherently Pb-Free.

# MC74HC595A

## MAXIMUM RATINGS

| Symbol    | Parameter   | Value                   | Unit |
|-----------|---|-------------------------|------|
| $V_{CC}$  | DC Supply Voltage (Referenced to GND)   | - 0.5 to + 7.0          | V    |
| $V_{in}$  | DC Input Voltage (Referenced to GND)  | - 0.5 to $V_{CC} + 0.5$ | V    |
| $V_{out}$ | DC Output Voltage (Referenced to GND)   | - 0.5 to $V_{CC} + 0.5$ | V    |
| $I_{in}$  | DC Input Current, per Pin   | $\pm 20$                | mA   |
| $I_{out}$ | DC Output Current, per Pin  | $\pm 35$                | mA   |
| $I_{CC}$  | DC Supply Current, $V_{CC}$ and GND Pins  | $\pm 75$                | mA   |
| $P_D$     | Power Dissipation in Still Air,<br>Plastic DIP†<br>SOIC Package†<br>TSSOP Package†      | 750<br>500<br>450       | mW   |
| $T_{stg}$ | Storage Temperature   | - 65 to + 150           | °C   |
| $T_L$     | Lead Temperature, 1 mm from Case for 10 Seconds<br>(Plastic DIP, SOIC or TSSOP Package) | 260                     | °C   |

This device contains protection circuitry to guard against damage due to high static voltages or electric fields. However, precautions must be taken to avoid applications of any voltage higher than maximum rated voltages to this high-impedance circuit. For proper operation,  $V_{in}$  and  $V_{out}$  should be constrained to the range  $GND \leq (V_{in} \text{ or } V_{out}) \leq V_{CC}$ . Unused inputs must always be tied to an appropriate logic voltage level (e.g., either GND or  $V_{CC}$ ). Unused outputs must be left open.

Stresses exceeding Maximum Ratings may damage the device. Maximum Ratings are stress ratings only. Functional operation above the Recommended Operating Conditions is not implied. Extended exposure to stresses above the Recommended Operating Conditions may affect device reliability.

†Derating — Plastic DIP: - 10 mW/°C from 65° to 125°C  
SOIC Package: - 7 mW/°C from 65° to 125°C  
TSSOP Package: - 6.1 mW/°C from 65° to 125°C

For high frequency or heavy load considerations, see Chapter 2 of the ON Semiconductor High-Speed CMOS Data Book (DL129/D).

## RECOMMENDED OPERATING CONDITIONS

| Symbol            | Parameter   | Min  | Max         | Unit               |    |
|-------------------|---|--|-------------|--------------------|----|
| $V_{CC}$          | DC Supply Voltage (Referenced to GND)                   | 2.0  | 6.0         | V                  |    |
| $V_{in}, V_{out}$ | DC Input Voltage, Output Voltage<br>(Referenced to GND) | 0  | $V_{CC}$    | V                  |    |
| $T_A$             | Operating Temperature, All Package Types                | - 55   | + 125       | °C                 |    |
| $t_r, t_f$        | Input Rise and Fall Time<br>(Figure 1)                  | $V_{CC} = 2.0 \text{ V}$<br>$V_{CC} = 4.5 \text{ V}$<br>$V_{CC} = 6.0 \text{ V}$ | 0<br>0<br>0 | 1000<br>500<br>400 | ns |

## DC ELECTRICAL CHARACTERISTICS (Voltages Referenced to GND)

| Symbol   | Parameter                                      | Test Conditions  | $V_{CC}$<br>V                   | Guaranteed Limit |        |         | Unit |     |
|----------|--|--|---------------------------------|------------------|--------|---------|------|-----|
|          |  |  |                                 | - 55 to 25°C     | ≤ 85°C | ≤ 125°C |      |     |
| $V_{IH}$ | Minimum High-Level Input Voltage               | $V_{out} = 0.1 \text{ V}$ or $V_{CC} - 0.1 \text{ V}$<br>$ I_{out}  \leq 20 \mu\text{A}$ | 2.0                             | 1.5              | 1.5    | 1.5     | V    |     |
|          |  |  | 3.0                             | 2.1              | 2.1    | 2.1     |      |     |
|          |  |  | 4.5                             | 3.15             | 3.15   | 3.15    |      |     |
|          |  |  | 6.0                             | 4.2              | 4.2    | 4.2     |      |     |
| $V_{IL}$ | Maximum Low-Level Input Voltage                | $V_{out} = 0.1 \text{ V}$ or $V_{CC} - 0.1 \text{ V}$<br>$ I_{out}  \leq 20 \mu\text{A}$ | 2.0                             | 0.5              | 0.5    | 0.5     | V    |     |
|          |  |  | 3.0                             | 0.9              | 0.9    | 0.9     |      |     |
|          |  |  | 4.5                             | 1.35             | 1.35   | 1.35    |      |     |
|          |  |  | 6.0                             | 1.8              | 1.8    | 1.8     |      |     |
| $V_{OH}$ | Minimum High-Level Output Voltage, $Q_A - Q_H$ | $V_{in} = V_{IH}$ or $V_{IL}$<br>$ I_{out}  \leq 20 \mu\text{A}$                         | 2.0                             | 1.9              | 1.9    | 1.9     | V    |     |
|          |  |  | 4.5                             | 4.4              | 4.4    | 4.4     |      |     |
|          |  |  | 6.0                             | 5.9              | 5.9    | 5.9     |      |     |
|          |  | $V_{in} = V_{IH}$ or $V_{IL}$  | $ I_{out}  \leq 2.4 \text{ mA}$ | 3.0              | 2.48   | 2.34    |      | 2.2 |
|          |  |  | $ I_{out}  \leq 6.0 \text{ mA}$ | 4.5              | 3.98   | 3.84    |      | 3.7 |
|          |  |  | $ I_{out}  \leq 7.8 \text{ mA}$ | 6.0              | 5.48   | 5.34    |      | 5.2 |

# MC74HC595A

## DC ELECTRICAL CHARACTERISTICS (Voltages Referenced to GND)

| Symbol          | Parameter  | Test Conditions  | V <sub>CC</sub><br>V | Guaranteed Limit |         |          | Unit |
|-----------------|--|--|----------------------|------------------|---------|----------|------|
|                 |  |  |                      | - 55 to 25 °C    | ≤ 85 °C | ≤ 125 °C |      |
| V <sub>OL</sub> | Maximum Low-Level Output Voltage, Q <sub>A</sub> - Q <sub>H</sub>    | V <sub>in</sub> = V <sub>IH</sub> or V <sub>IL</sub><br> I <sub>out</sub>   ≤ 20 μA  | 2.0                  | 0.1              | 0.1     | 0.1      | V    |
|                 |  |  | 4.5                  | 0.1              | 0.1     | 0.1      |      |
|                 |  |  | 6.0                  | 0.1              | 0.1     | 0.1      |      |
|                 |  | V <sub>in</sub> = V <sub>IH</sub> or V <sub>IL</sub><br> I <sub>out</sub>   ≤ 2.4 mA<br> I <sub>out</sub>   ≤ 6.0 mA<br> I <sub>out</sub>   ≤ 7.8 mA | 3.0                  | 0.26             | 0.33    | 0.4      |      |
|                 |  |  | 4.5                  | 0.26             | 0.33    | 0.4      |      |
|                 |  |  | 6.0                  | 0.26             | 0.33    | 0.4      |      |
| V <sub>OH</sub> | Minimum High-Level Output Voltage, SQ <sub>H</sub>                   | V <sub>in</sub> = V <sub>IH</sub> or V <sub>IL</sub><br> I <sub>out</sub>   ≤ 20 μA  | 2.0                  | 1.9              | 1.9     | 1.9      | V    |
|                 |  |  | 4.5                  | 4.4              | 4.4     | 4.4      |      |
|                 |  |  | 6.0                  | 5.9              | 5.9     | 5.9      |      |
|                 |  | V <sub>in</sub> = V <sub>IH</sub> or V <sub>IL</sub><br> I <sub>out</sub>   ≤ 2.4 mA<br> I <sub>out</sub>   ≤ 4.0 mA<br> I <sub>out</sub>   ≤ 5.2 mA | 3.0                  | 2.98             | 2.34    | 2.2      |      |
|                 |  |  | 4.5                  | 3.98             | 3.84    | 3.7      |      |
|                 |  |  | 6.0                  | 5.48             | 5.34    | 5.2      |      |
| V <sub>OL</sub> | Maximum Low-Level Output Voltage, SQ <sub>H</sub>                    | V <sub>in</sub> = V <sub>IH</sub> or V <sub>IL</sub><br> I <sub>out</sub>   ≤ 20 μA  | 2.0                  | 0.1              | 0.1     | 0.1      | V    |
|                 |  |  | 4.5                  | 0.1              | 0.1     | 0.1      |      |
|                 |  |  | 6.0                  | 0.1              | 0.1     | 0.1      |      |
|                 |  | V <sub>in</sub> = V <sub>IH</sub> or V <sub>IL</sub><br> I <sub>out</sub>   ≤ 2.4 mA<br> I <sub>out</sub>   ≤ 4.0 mA<br> I <sub>out</sub>   ≤ 5.2 mA | 3.0                  | 0.26             | 0.33    | 0.4      |      |
|                 |  |  | 4.5                  | 0.26             | 0.33    | 0.4      |      |
|                 |  |  | 6.0                  | 0.26             | 0.33    | 0.4      |      |
| I <sub>in</sub> | Maximum Input Leakage Current  | V <sub>in</sub> = V <sub>CC</sub> or GND   | 6.0                  | ± 0.1            | ± 1.0   | ± 1.0    | μA   |
| I <sub>OZ</sub> | Maximum Three-State Leakage Current, Q <sub>A</sub> - Q <sub>H</sub> | Output in High-Impedance State<br>V <sub>in</sub> = V <sub>IL</sub> or V <sub>IH</sub><br>V <sub>out</sub> = V <sub>CC</sub> or GND                  | 6.0                  | ± 0.5            | ± 5.0   | ± 10     | μA   |
| I <sub>CC</sub> | Maximum Quiescent Supply Current (per Package)                       | V <sub>in</sub> = V <sub>CC</sub> or GND<br>I <sub>out</sub> = 0 μA  | 6.0                  | 4.0              | 40      | 160      | μA   |

NOTE: Information on typical parametric values can be found in Chapter 2 of the ON Semiconductor High-Speed CMOS Data Book (DL129/D).

## AC ELECTRICAL CHARACTERISTICS (C<sub>L</sub> = 50 pF, Input t<sub>r</sub> = t<sub>f</sub> = 6.0 ns)

| Symbol                                 | Parameter  | V <sub>CC</sub><br>V | Guaranteed Limit |         |          | Unit |
|--|--|----------------------|------------------|---------|----------|------|
|  |  |                      | - 55 to 25 °C    | ≤ 85 °C | ≤ 125 °C |      |
| f <sub>max</sub>                       | Maximum Clock Frequency (50% Duty Cycle)<br>(Figures 1 and 7)                                    | 2.0                  | 6.0              | 4.8     | 4.0      | MHz  |
|  |  | 3.0                  | 15               | 10      | 8.0      |      |
|  |  | 4.5                  | 30               | 24      | 20       |      |
|  |  | 6.0                  | 35               | 28      | 24       |      |
| t <sub>PLH</sub> ,<br>t <sub>PHL</sub> | Maximum Propagation Delay, Shift Clock to SQ <sub>H</sub><br>(Figures 1 and 7)                   | 2.0                  | 140              | 175     | 210      | ns   |
|  |  | 3.0                  | 100              | 125     | 150      |      |
|  |  | 4.5                  | 28               | 35      | 42       |      |
|  |  | 6.0                  | 24               | 30      | 36       |      |
| t <sub>PHL</sub>                       | Maximum Propagation Delay, Reset to SQ <sub>H</sub><br>(Figures 2 and 7)                         | 2.0                  | 145              | 180     | 220      | ns   |
|  |  | 3.0                  | 100              | 125     | 150      |      |
|  |  | 4.5                  | 29               | 36      | 44       |      |
|  |  | 6.0                  | 25               | 31      | 38       |      |
| t <sub>PLH</sub> ,<br>t <sub>PHL</sub> | Maximum Propagation Delay, Latch Clock to Q <sub>A</sub> - Q <sub>H</sub><br>(Figures 3 and 7)   | 2.0                  | 140              | 175     | 210      | ns   |
|  |  | 3.0                  | 100              | 125     | 150      |      |
|  |  | 4.5                  | 28               | 35      | 42       |      |
|  |  | 6.0                  | 24               | 30      | 36       |      |
| t <sub>PZL</sub> ,<br>t <sub>PHZ</sub> | Maximum Propagation Delay, Output Enable to Q <sub>A</sub> - Q <sub>H</sub><br>(Figures 4 and 8) | 2.0                  | 150              | 190     | 225      | ns   |
|  |  | 3.0                  | 100              | 125     | 150      |      |
|  |  | 4.5                  | 30               | 38      | 45       |      |
|  |  | 6.0                  | 26               | 33      | 38       |      |
| t <sub>PZL</sub> ,<br>t <sub>PZH</sub> | Maximum Propagation Delay, Output Enable to Q <sub>A</sub> - Q <sub>H</sub><br>(Figures 4 and 8) | 2.0                  | 135              | 170     | 205      | ns   |
|  |  | 3.0                  | 90               | 110     | 130      |      |
|  |  | 4.5                  | 27               | 34      | 41       |      |
|  |  | 6.0                  | 23               | 29      | 35       |      |

# MC74HC595A

## AC ELECTRICAL CHARACTERISTICS ( $C_L = 50 \text{ pF}$ , Input $t_r = t_f = 6.0 \text{ ns}$ )

| Symbol                                 | Parameter  | V <sub>CC</sub><br>V | Guaranteed Limit |        |         | Unit |
|--|--|----------------------|------------------|--------|---------|------|
|  |  |                      | - 55 to 25°C     | ≤ 85°C | ≤ 125°C |      |
| t <sub>TLH</sub> ,<br>t <sub>THL</sub> | Maximum Output Transition Time, Q <sub>A</sub> - Q <sub>H</sub><br>(Figures 3 and 7)                     | 2.0                  | 60               | 75     | 90      | ns   |
|  |  | 3.0                  | 23               | 27     | 31      |      |
|  |  | 4.5                  | 12               | 15     | 18      |      |
|  |  | 6.0                  | 10               | 13     | 15      |      |
| t <sub>TLH</sub> ,<br>t <sub>THL</sub> | Maximum Output Transition Time, SQ <sub>H</sub><br>(Figures 1 and 7)                                     | 2.0                  | 75               | 95     | 110     | ns   |
|  |  | 3.0                  | 27               | 32     | 36      |      |
|  |  | 4.5                  | 15               | 19     | 22      |      |
|  |  | 6.0                  | 13               | 16     | 19      |      |
| C <sub>in</sub>                        | Maximum Input Capacitance  | —                    | 10               | 10     | 10      | pF   |
| C <sub>out</sub>                       | Maximum Three-State Output Capacitance (Output in High-Impedance State), Q <sub>A</sub> - Q <sub>H</sub> | —                    | 15               | 15     | 15      | pF   |

NOTE: For propagation delays with loads other than 50 pF, and information on typical parametric values, see Chapter 2 of the ON Semiconductor High-Speed CMOS Data Book (DL129/D).

| C <sub>PD</sub> | Power Dissipation Capacitance (Per Package)* | Typical @ 25°C, V <sub>CC</sub> = 5.0 V |  | pF |
|-----------------|--|---|--|----|
|                 |  | 300                                     |  |    |
|                 |  |   |  |    |

\* Used to determine the no-load dynamic power consumption:  $P_D = C_{PD} V_{CC}^2 f + I_{CC} V_{CC}$ . For load considerations, see Chapter 2 of the ON Semiconductor High-Speed CMOS Data Book (DL129/D).

## TIMING REQUIREMENTS (Input $t_r = t_f = 6.0 \text{ ns}$ )

| Symbol                          | Parameter  | V <sub>CC</sub><br>V | Guaranteed Limit |        |         | Unit |
|---------------------------------|--|----------------------|------------------|--------|---------|------|
|                                 |  |                      | 25°C to -55°C    | ≤ 85°C | ≤ 125°C |      |
| t <sub>su</sub>                 | Minimum Setup Time, Serial Data Input A to Shift Clock<br>(Figure 5) | 2.0                  | 50               | 65     | 75      | ns   |
|                                 |  | 3.0                  | 40               | 50     | 60      |      |
|                                 |  | 4.5                  | 10               | 13     | 15      |      |
|                                 |  | 6.0                  | 9.0              | 11     | 13      |      |
| t <sub>su</sub>                 | Minimum Setup Time, Shift Clock to Latch Clock<br>(Figure 6)         | 2.0                  | 75               | 95     | 110     | ns   |
|                                 |  | 3.0                  | 60               | 70     | 80      |      |
|                                 |  | 4.5                  | 15               | 19     | 22      |      |
|                                 |  | 6.0                  | 13               | 16     | 19      |      |
| t <sub>h</sub>                  | Minimum Hold Time, Shift Clock to Serial Data Input A<br>(Figure 5)  | 2.0                  | 5.0              | 5.0    | 5.0     | ns   |
|                                 |  | 3.0                  | 5.0              | 5.0    | 5.0     |      |
|                                 |  | 4.5                  | 5.0              | 5.0    | 5.0     |      |
|                                 |  | 6.0                  | 5.0              | 5.0    | 5.0     |      |
| t <sub>rec</sub>                | Minimum Recovery Time, Reset Inactive to Shift Clock<br>(Figure 2)   | 2.0                  | 50               | 65     | 75      | ns   |
|                                 |  | 3.0                  | 40               | 50     | 60      |      |
|                                 |  | 4.5                  | 10               | 13     | 15      |      |
|                                 |  | 6.0                  | 9.0              | 11     | 13      |      |
| t <sub>w</sub>                  | Minimum Pulse Width, Reset<br>(Figure 2)                             | 2.0                  | 60               | 75     | 90      | ns   |
|                                 |  | 3.0                  | 45               | 60     | 70      |      |
|                                 |  | 4.5                  | 12               | 15     | 18      |      |
|                                 |  | 6.0                  | 10               | 13     | 15      |      |
| t <sub>w</sub>                  | Minimum Pulse Width, Shift Clock<br>(Figure 1)                       | 2.0                  | 50               | 65     | 75      | ns   |
|                                 |  | 3.0                  | 40               | 50     | 60      |      |
|                                 |  | 4.5                  | 10               | 13     | 15      |      |
|                                 |  | 6.0                  | 9.0              | 11     | 13      |      |
| t <sub>w</sub>                  | Minimum Pulse Width, Latch Clock<br>(Figure 6)                       | 2.0                  | 50               | 65     | 75      | ns   |
|                                 |  | 3.0                  | 40               | 50     | 60      |      |
|                                 |  | 4.5                  | 10               | 13     | 15      |      |
|                                 |  | 6.0                  | 9.0              | 11     | 13      |      |
| t <sub>r</sub> , t <sub>f</sub> | Maximum Input Rise and Fall Times<br>(Figure 1)                      | 2.0                  | 1000             | 1000   | 1000    | ns   |
|                                 |  | 3.0                  | 800              | 800    | 800     |      |
|                                 |  | 4.5                  | 500              | 500    | 500     |      |
|                                 |  | 6.0                  | 400              | 400    | 400     |      |

# MC74HC595A

## FUNCTION TABLE

| Operation  | Inputs |                |             |             |               | Resulting Function   |                                   |                                   |  |
|--|--------|----------------|-------------|-------------|---------------|--|-----------------------------------|-----------------------------------|--|
|  | Reset  | Serial Input A | Shift Clock | Latch Clock | Output Enable | Shift Register Contents                                      | Latch Register Contents           | Serial Output SQ <sub>H</sub>     | Parallel Outputs Q <sub>A</sub> - Q <sub>H</sub> |
| Reset shift register                               | L      | X              | X           | L, H, ↓     | L             | L  | U                                 | L                                 | U  |
| Shift data into shift register                     | H      | D              | ↑           | L, H, ↓     | L             | D → SR <sub>A</sub> ;<br>SR <sub>N</sub> → SR <sub>N+1</sub> | U                                 | SR <sub>G</sub> → SR <sub>H</sub> | U  |
| Shift register remains unchanged                   | H      | X              | L, H, ↓     | L, H, ↓     | L             | U  | U                                 | U                                 | U  |
| Transfer shift register contents to latch register | H      | X              | L, H, ↓     | ↑           | L             | U  | SR <sub>N</sub> → LR <sub>N</sub> | U                                 | SR <sub>N</sub>                                  |
| Latch register remains unchanged                   | X      | X              | X           | L, H, ↓     | L             | *  | U                                 | *                                 | U  |
| Enable parallel outputs                            | X      | X              | X           | X           | L             | *  | **                                | *                                 | Enabled  |
| Force outputs into high impedance state            | X      | X              | X           | X           | H             | *  | **                                | *                                 | Z  |

SR = shift register contents  
LR = latch register contents

D = data (L, H) logic level  
U = remains unchanged

↑ = Low-to-High  
↓ = High-to-Low

\* = depends on Reset and Shift Clock inputs  
\*\* = depends on Latch Clock input

## PIN DESCRIPTIONS

### INPUTS A (Pin 14)

Serial Data Input. The data on this pin is shifted into the 8-bit serial shift register.

### CONTROL INPUTS Shift Clock (Pin 11)

Shift Register Clock Input. A low-to-high transition on this input causes the data at the Serial Input pin to be shifted into the 8-bit shift register.

### Reset (Pin 10)

Active-low, Asynchronous, Shift Register Reset Input. A low on this pin resets the shift register portion of this device only. The 8-bit latch is not affected.

### Latch Clock (Pin 12)

Storage Latch Clock Input. A low-to-high transition on this input latches the shift register data.

### Output Enable (Pin 13)

Active-low Output Enable. A low on this input allows the data from the latches to be presented at the outputs. A high on this input forces the outputs (Q<sub>A</sub>-Q<sub>H</sub>) into the high-impedance state. The serial output is not affected by this control unit.

### OUTPUTS Q<sub>A</sub> - Q<sub>H</sub> (Pins 15, 1, 2, 3, 4, 5, 6, 7)

Noninverted, 3-state, latch outputs.

### SQ<sub>H</sub> (Pin 9)

Noninverted, Serial Data Output. This is the output of the eighth stage of the 8-bit shift register. This output does not have three-state capability.

# MC74HC595A

## SWITCHING WAVEFORMS

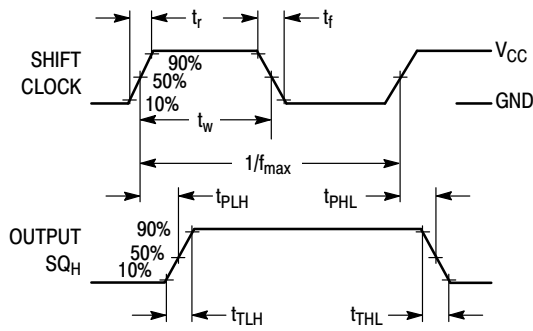

Figure 1.

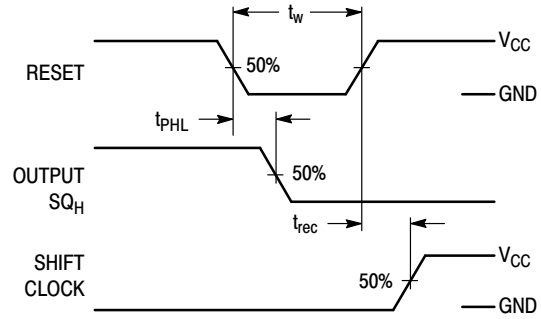

Figure 2.

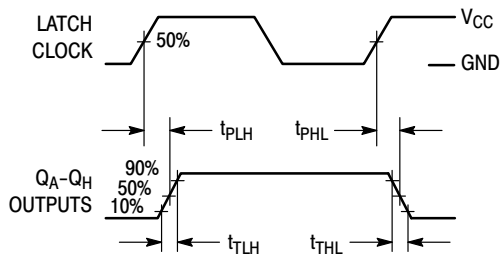

Figure 3.

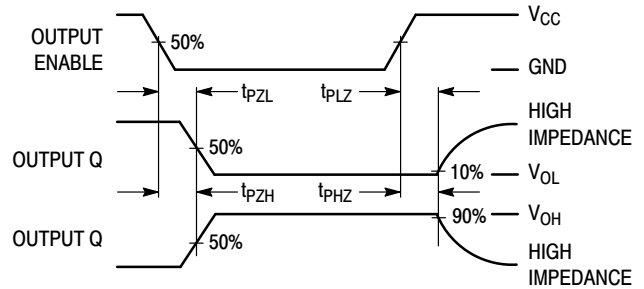

Figure 4.

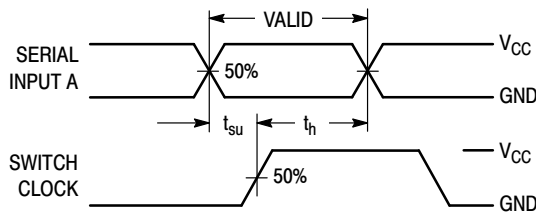

Figure 5.

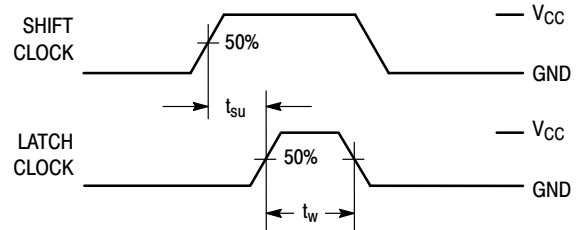
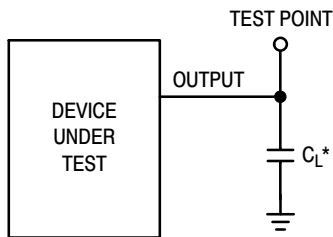

Figure 6.

## TEST CIRCUITS



\*Includes all probe and jig capacitance

Figure 7.

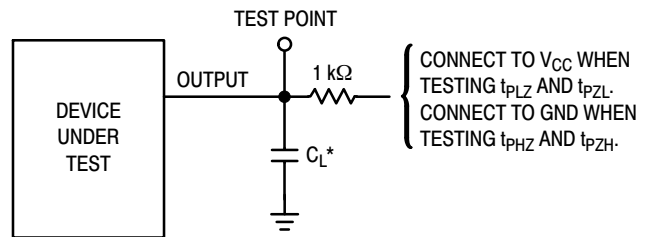

\*Includes all probe and jig capacitance

Figure 8.

# MC74HC595A

## EXPANDED LOGIC DIAGRAM





# MC74HC595A

## TIMING DIAGRAM

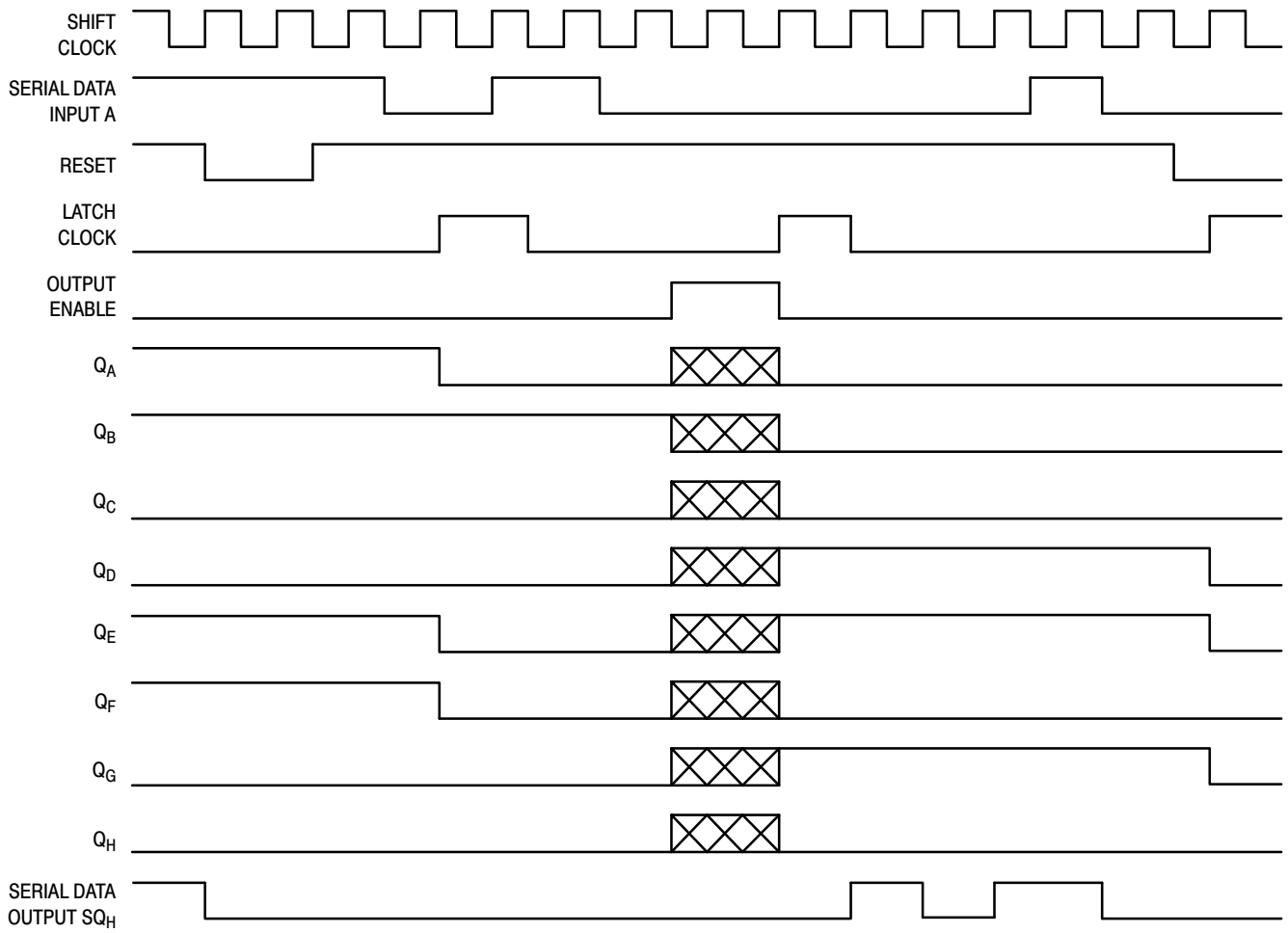

NOTE:  implies that the output is in a high-impedance state.

# MC74HC595A

## PACKAGE DIMENSIONS

**PDIP-16**  
**N SUFFIX**  
CASE 648-08  
ISSUE T

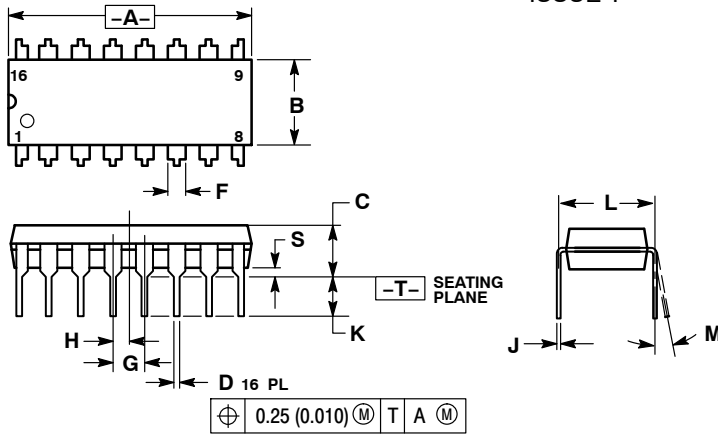

**NOTES:**

1. DIMENSIONING AND TOLERANCING PER ANSI Y14.5M, 1982.
2. CONTROLLING DIMENSION: INCH.
3. DIMENSION L TO CENTER OF LEADS WHEN FORMED PARALLEL.
4. DIMENSION B DOES NOT INCLUDE MOLD FLASH.
5. ROUNDED CORNERS OPTIONAL.

| DIM | INCHES    |       | MILLIMETERS |       |
|-----|-----------|-------|-------------|-------|
|     | MIN       | MAX   | MIN         | MAX   |
| A   | 0.740     | 0.770 | 18.80       | 19.55 |
| B   | 0.250     | 0.270 | 6.35        | 6.85  |
| C   | 0.145     | 0.175 | 3.69        | 4.44  |
| D   | 0.015     | 0.021 | 0.39        | 0.53  |
| F   | 0.040     | 0.70  | 1.02        | 1.77  |
| G   | 0.100 BSC |       | 2.54 BSC    |       |
| H   | 0.050 BSC |       | 1.27 BSC    |       |
| J   | 0.008     | 0.015 | 0.21        | 0.38  |
| K   | 0.110     | 0.130 | 2.80        | 3.30  |
| L   | 0.295     | 0.305 | 7.50        | 7.74  |
| M   | 0°        | 10°   | 0°          | 10°   |
| S   | 0.020     | 0.040 | 0.51        | 1.01  |

**SOIC-16**  
**D SUFFIX**  
CASE 751B-05  
ISSUE J

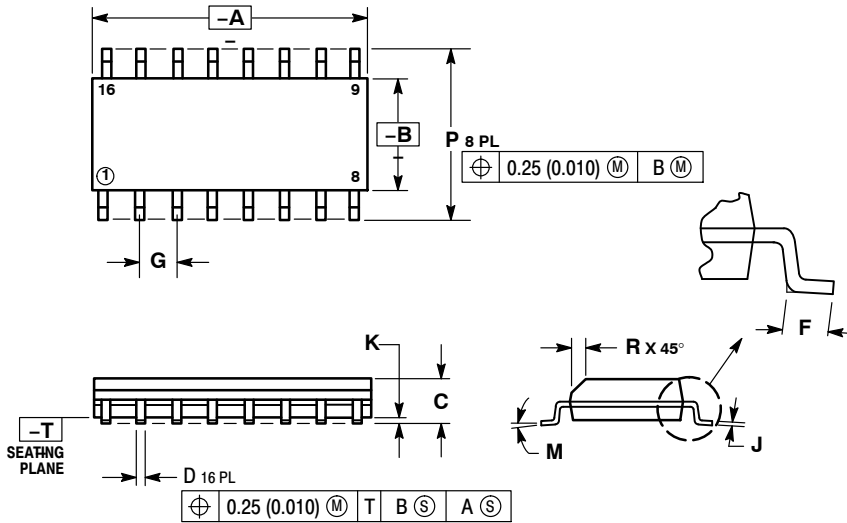

**NOTES:**

1. DIMENSIONING AND TOLERANCING PER ANSI Y14.5M, 1982.
2. CONTROLLING DIMENSION: MILLIMETER.
3. DIMENSIONS A AND B DO NOT INCLUDE MOLD PROTRUSION.
4. MAXIMUM MOLD PROTRUSION 0.15 (0.006) PER SIDE.
5. DIMENSION D DOES NOT INCLUDE DAMBAR PROTRUSION. ALLOWABLE DAMBAR PROTRUSION SHALL BE 0.127 (0.005) TOTAL IN EXCESS OF THE D DIMENSION AT MAXIMUM MATERIAL CONDITION.

| DIM | MILLIMETERS |       | INCHES    |       |
|-----|-------------|-------|-----------|-------|
|     | MIN         | MAX   | MIN       | MAX   |
| A   | 9.80        | 10.00 | 0.386     | 0.393 |
| B   | 3.80        | 4.00  | 0.150     | 0.157 |
| C   | 1.35        | 1.75  | 0.054     | 0.068 |
| D   | 0.35        | 0.49  | 0.014     | 0.019 |
| F   | 0.40        | 1.25  | 0.016     | 0.049 |
| G   | 1.27 BSC    |       | 0.050 BSC |       |
| J   | 0.19        | 0.25  | 0.008     | 0.009 |
| K   | 0.10        | 0.25  | 0.004     | 0.009 |
| M   | 0°          | 7°    | 0°        | 7°    |
| P   | 5.80        | 6.20  | 0.229     | 0.244 |
| R   | 0.25        | 0.50  | 0.010     | 0.019 |

### SOLDERING FOOTPRINT

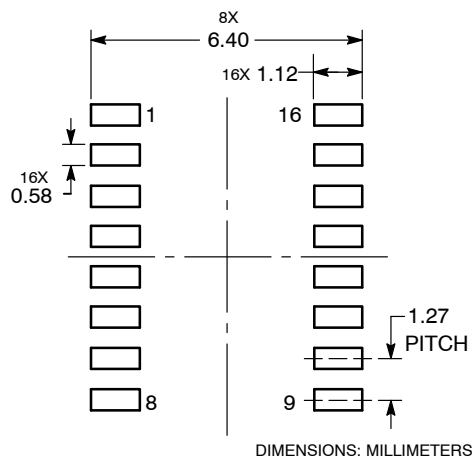

# MC74HC595A

## PACKAGE DIMENSIONS

TSSOP-16  
DT SUFFIX  
CASE 948F-01  
ISSUE B

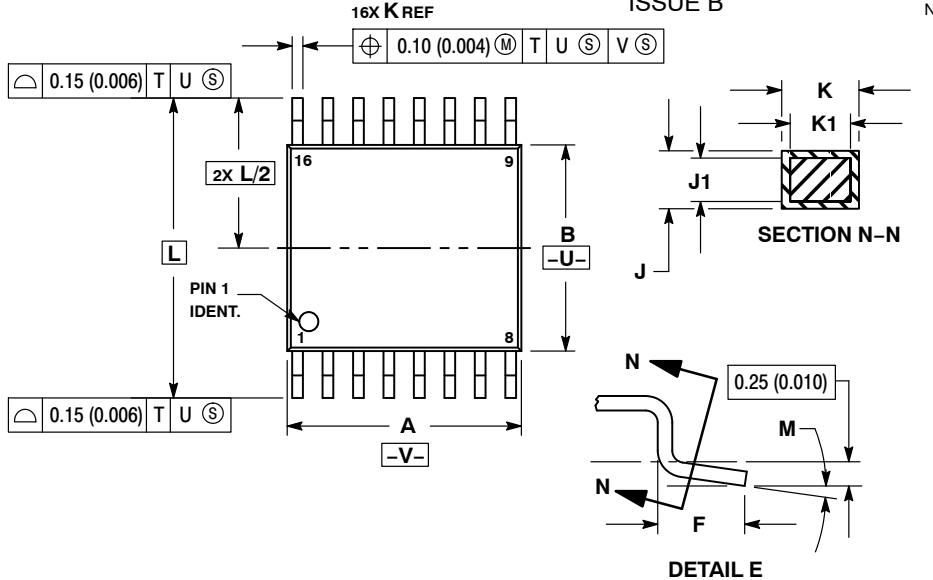

- NOTES:
1. DIMENSIONING AND TOLERANCING PER ANSI Y14.5M, 1982.
  2. CONTROLLING DIMENSION: MILLIMETER.
  3. DIMENSION A DOES NOT INCLUDE MOLD FLASH, PROTRUSIONS OR GATE BURRS. MOLD FLASH OR GATE BURRS SHALL NOT EXCEED 0.15 (0.006) PER SIDE.
  4. DIMENSION B DOES NOT INCLUDE INTERLEAD FLASH OR PROTRUSION. INTERLEAD FLASH OR PROTRUSION SHALL NOT EXCEED 0.25 (0.010) PER SIDE.
  5. DIMENSION K DOES NOT INCLUDE DAMBAR PROTRUSION. ALLOWABLE DAMBAR PROTRUSION SHALL BE 0.08 (0.003) TOTAL IN EXCESS OF THE K DIMENSION AT MAXIMUM MATERIAL CONDITION.
  6. TERMINAL NUMBERS ARE SHOWN FOR REFERENCE ONLY.
  7. DIMENSION A AND B ARE TO BE DETERMINED AT DATUM PLANE -W-.

| DIM | MILLIMETERS |      | INCHES    |       |
|-----|-------------|------|-----------|-------|
|     | MIN         | MAX  | MIN       | MAX   |
| A   | 4.90        | 5.10 | 0.193     | 0.200 |
| B   | 4.30        | 4.50 | 0.169     | 0.177 |
| C   | ---         | 1.20 | ---       | 0.047 |
| D   | 0.05        | 0.15 | 0.002     | 0.006 |
| F   | 0.50        | 0.75 | 0.020     | 0.030 |
| G   | 0.65 BSC    |      | 0.026 BSC |       |
| H   | 0.18        | 0.28 | 0.007     | 0.011 |
| J   | 0.09        | 0.20 | 0.004     | 0.008 |
| J1  | 0.09        | 0.16 | 0.004     | 0.006 |
| K   | 0.19        | 0.30 | 0.007     | 0.012 |
| K1  | 0.19        | 0.25 | 0.007     | 0.010 |
| L   | 6.40 BSC    |      | 0.252 BSC |       |
| M   | 0°          | 8°   | 0°        | 8°    |

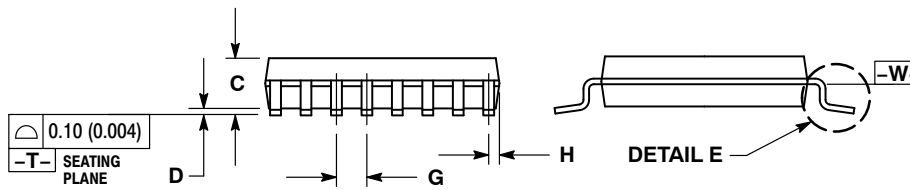

### SOLDERING FOOTPRINT

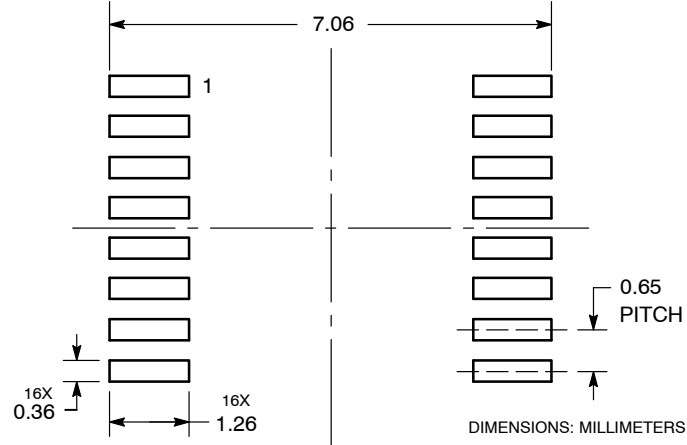

**ON Semiconductor** and **ON** are registered trademarks of Semiconductor Components Industries, LLC (SCILLC). SCILLC reserves the right to make changes without further notice to any products herein. SCILLC makes no warranty, representation or guarantee regarding the suitability of its products for any particular purpose, nor does SCILLC assume any liability arising out of the application or use of any product or circuit, and specifically disclaims any and all liability, including without limitation special, consequential or incidental damages. "Typical" parameters which may be provided in SCILLC data sheets and/or specifications can and do vary in different applications and actual performance may vary over time. All operating parameters, including "Typicals" must be validated for each customer application by customer's technical experts. SCILLC does not convey any license under its patent rights nor the rights of others. SCILLC products are not designed, intended, or authorized for use as components in systems intended for surgical implant into the body, or other applications intended to support or sustain life, or for any other application in which the failure of the SCILLC product could create a situation where personal injury or death may occur. Should Buyer purchase or use SCILLC products for any such unintended or unauthorized application, Buyer shall indemnify and hold SCILLC and its officers, employees, subsidiaries, affiliates, and distributors harmless against all claims, costs, damages, and expenses, and reasonable attorney fees arising out of, directly or indirectly, any claim of personal injury or death associated with such unintended or unauthorized use, even if such claim alleges that SCILLC was negligent regarding the design or manufacture of the part. SCILLC is an Equal Opportunity/Affirmative Action Employer. This literature is subject to all applicable copyright laws and is not for resale in any manner.

### PUBLICATION ORDERING INFORMATION

**LITERATURE FULFILLMENT:**  
Literature Distribution Center for ON Semiconductor  
P.O. Box 5163, Denver, Colorado 80217 USA  
**Phone:** 303-675-2175 or 800-344-3860 Toll Free USA/Canada  
**Fax:** 303-675-2176 or 800-344-3867 Toll Free USA/Canada  
**Email:** orderlit@onsemi.com

**N. American Technical Support:** 800-282-9855 Toll Free USA/Canada  
**Europe, Middle East and Africa Technical Support:**  
Phone: 421 33 790 2910  
**Japan Customer Focus Center**  
Phone: 81-3-5773-3850

**ON Semiconductor Website:** [www.onsemi.com](http://www.onsemi.com)  
**Order Literature:** <http://www.onsemi.com/orderlit>  
For additional information, please contact your local Sales Representative